

ISH²

INJECTION SAFETY HINGES

PATENT PENDING



ISH²

INJECTION SAFETY HINGES

33-04214

- ISH front hinge with double barrel
- Made from nickel silver
- Maintenance free anti-rocking front hinge
- Matching wire 70-07765
- Consistent & smooth temple movement
- For full acetate frames
- Can be bent (6°)

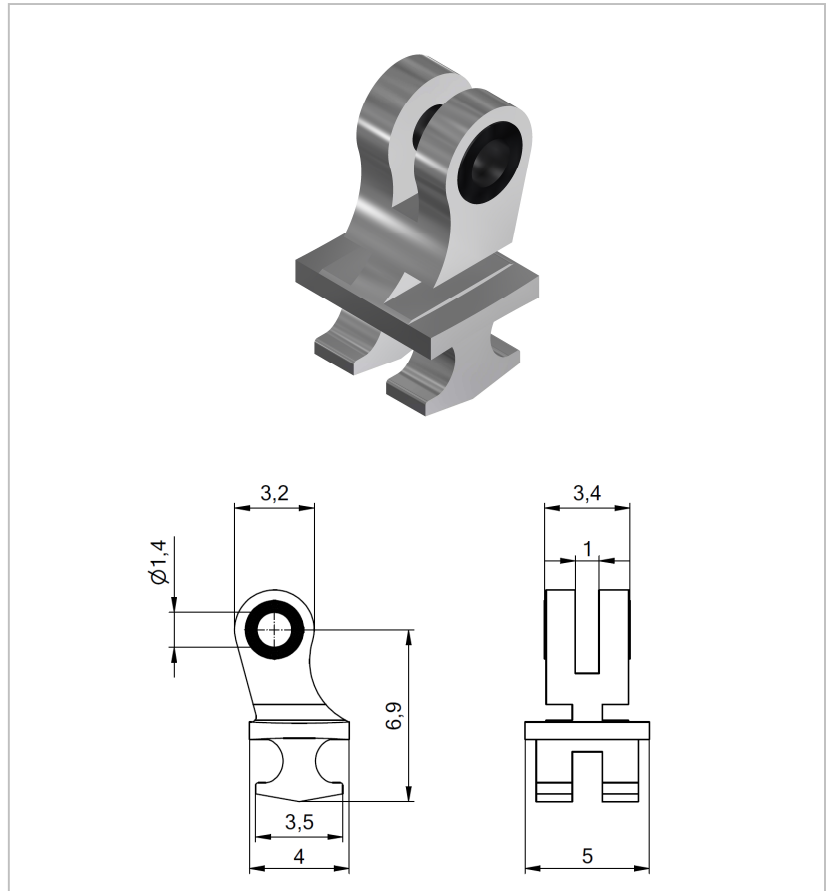

Screw 99-47140



OBE GmbH & Co. KG · Turnstr. 22 · 75228 Ispringen · Germany
Tel. +49 7231 802-0 · www.obe.de · info@obe.de